

Electrical Characteristics										
Frequency	Hz	50				60				
Voltage (parallel star)	V	380	400	415	440	415	440	460	480	
Rated power class H	kVA	1500	1500	1500	/	/	1710	1800	1800	
	kW	1200	1200	1200	/	/	1368	1440	1440	
Rated power class F	kVA	1350	1350	1350	/	/	1530	1620	1620	
	kW	1080	1080	1080	/	/	1224	1296	1296	
Regulation with UVR6		±1% with any power factor and speed variations between -5% +30%								
Insulation class		H								
Execution		Brushless								
Stator winding		12 ends								
Rotor		with damping cage								
Efficiencies class H	4/4	%	96,3	96,2	96	/	/	96,3	96,5	96,4
(see graph. for details)	3/4	%	96,7	96,4	96,5	/	/	96,5	96,9	96,6
	2/4	%	96	95,9	95,9	/	/	96	96,2	96,1
	1/4	%	95,3	95,3	95,1	/	/	95,2	95,3	95,4
Reactances (f. l.cl. F)	Xd	%	404,4	365	339,1	/	/	410,2	397,4	365
	Xd'	%	28,3	25,5	23,7	/	/	28,66	27,8	25,5
	Xd''	%	14,3	12,9	12,0	/	/	14,50	14,0	12,9
	Xq	%	186,1	168	156,1	/	/	188,8	182,9	168
	Xq'	%	186,1	168	156,1	/	/	188,8	182,9	168
	Xq''	%	31,2	28,2	26	/	/	31,7	30,7	28,2
	X ₂	%	20,5	18,5	17,2	/	/	20,79	20,1	18,5
	X ₀	%	4,5	4,1	4	/	/	4,61	4,5	4,1
Short Circuit Ratio	Kcc		0,32	0,38	0,40	/	/	0,30	0,32	0,38
Time Constants	Td'	sec.	0,250							
	Td''	sec.	0,021							
	Tdo'	sec.	9,50							
	Tα	sec.	0,027							
Short Circuit Current Capacity		%	>300				>350			
Excitation at no load	Amp.		0,6	0,7	0,8	/	/	0,5	0,6	0,65
Excitation at full load	Amp.		2,8	2,9	3	/	/	2,7	2,75	2,8
Overload (long-term)		%	1 hour in a 6 hours period 110% rated load							
Overload per 20 sec.		%	300							
Stator Winding Resistance (20°C)	Ω		0,0057							
Rotor Winding Resistance (20°C)	Ω		3,050							
Exciter Resistance (20 °C)	Ω		Rotor : 0,120				Stator : 12,90			
Heat dissipation at f.l.cl.H	W		46.106	47.401	50.000	/	/	52.561	52.228	53.776
Telephone Interference			FHT < 2%				TIF < 40			
Radio interference			EN50081-1, EN50082-1, VDE0875K. For others standards apply to factory							
Waveform Distors.(THD) at f. load	LL/LN %		3 / 2,9							
Waveform Distors.(THD) at no load	LL/LN %		2,5 / 2,4							
Mechanical characteristics										
Protection			IP 21 (other protection on request)							
DE bearing			NU2230							
NDE bearing			6324							
Weight of wound stator assembly	kg		1080							
Weight of wound rotor assembly	kg		668							
Weight of complete generator	kg		2770							
Maximun overspeed	rpm		2250							
Unbalanced magnetic pull at f.l.cl.F	kN/mm		6,4							
Cooling air requirement	m ³ /min		135				162			
Inertia Constant (H)	sec.		0,326				0,391			
Noise level at 1m/7m	dB(A)		97 / 86				100 / 91			

All technical data are to be considered as a reference and they can be modified without any notice.

This document is a propriety of Mecc Alte S.p.A.. All rights reserved.

50 Hz

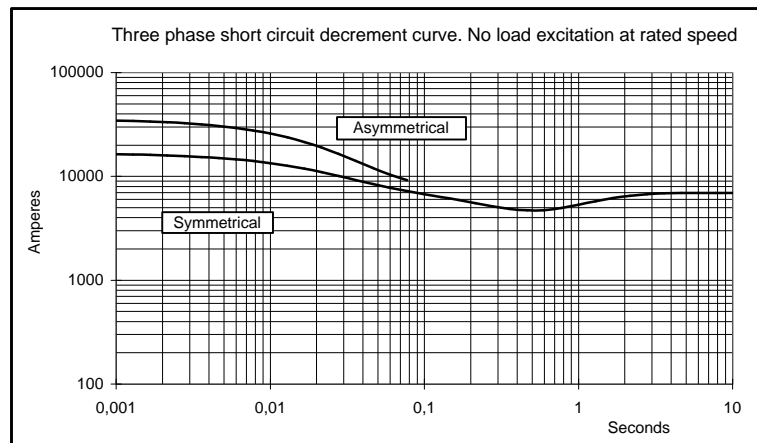
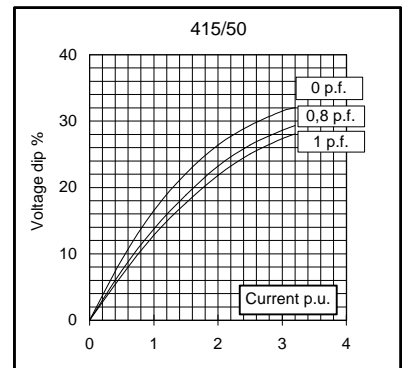
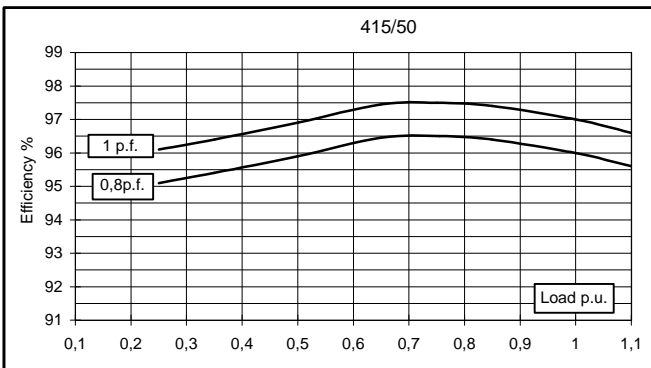
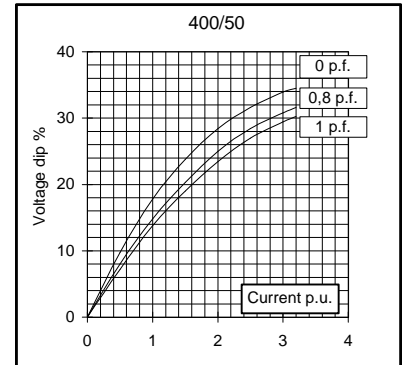
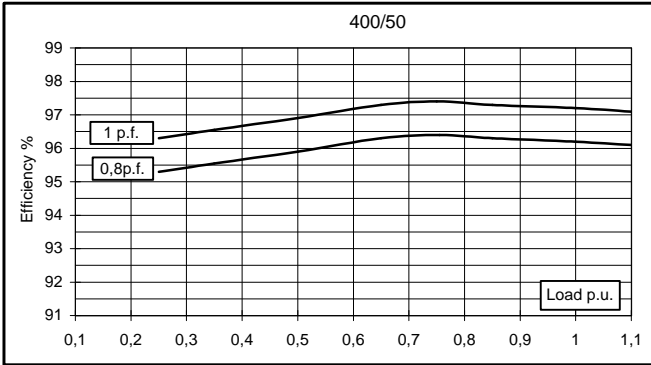
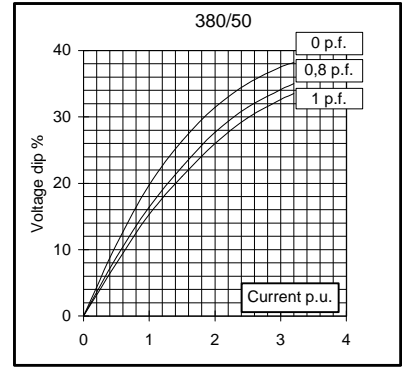
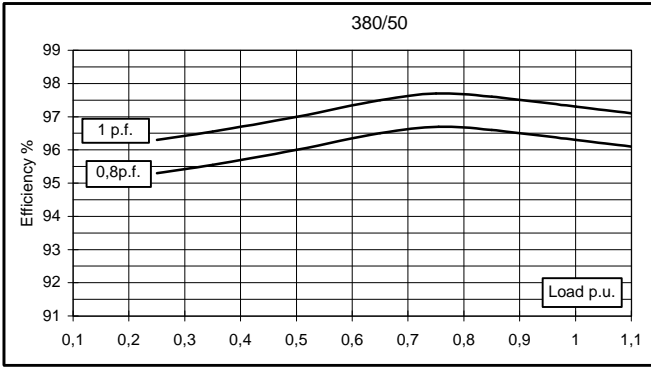

60 Hz

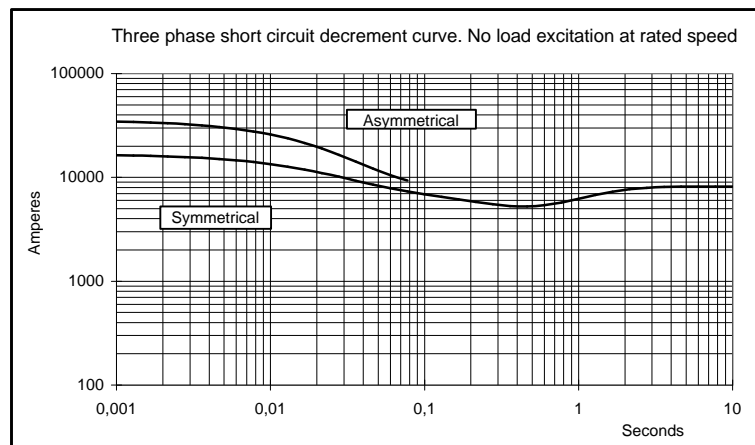
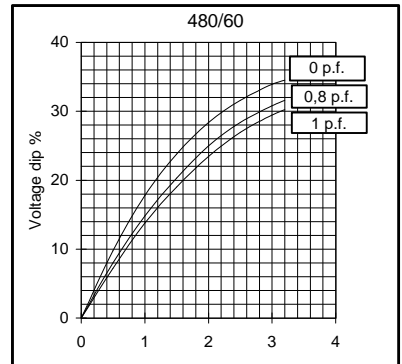
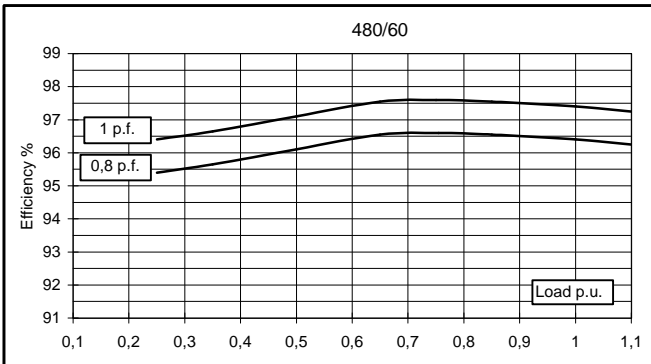
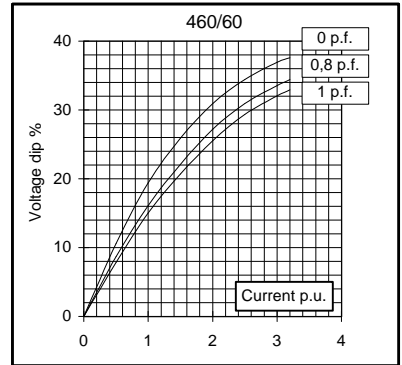
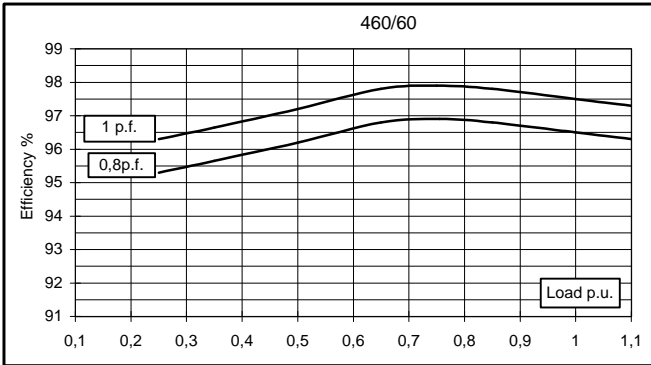
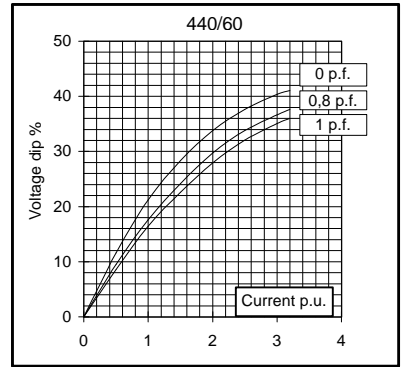
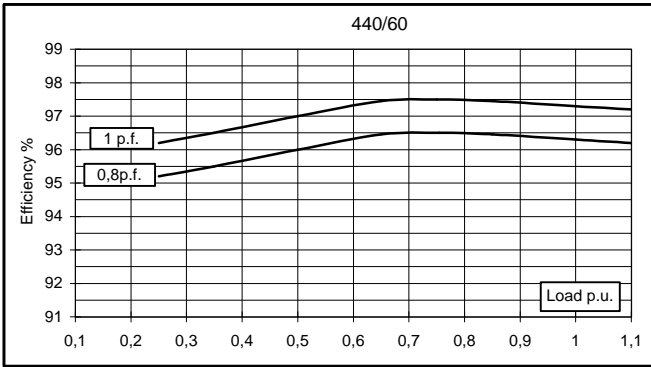

SINGLE BEARING MOMENTS OF INERTIA

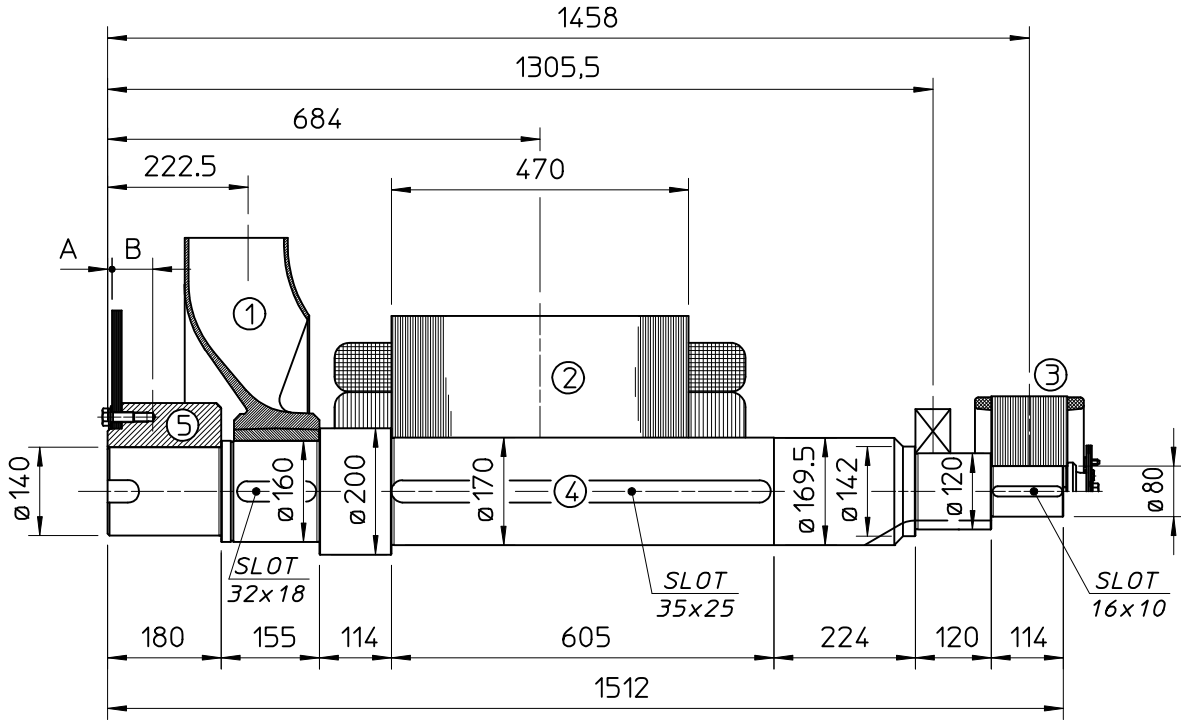

COMPONENT	WEIGHT kg	J kgm ²
1 FAN	45	3.45
2 MAIN ROTOR	668	34.40
3 EX. ROTOR	60	0.85
4 SHAFT	232	0.82
TOTAL	1005	39.52

COMPONENT	SAE N°	A	B	WEIGHT kg	J kgm ²
5 SHAFTS COUPLING FLEX PLATE	18	7.3	63.2	86	1.958
	21	23	54	99	3.484

SINGLE BEARING DIMENSIONS

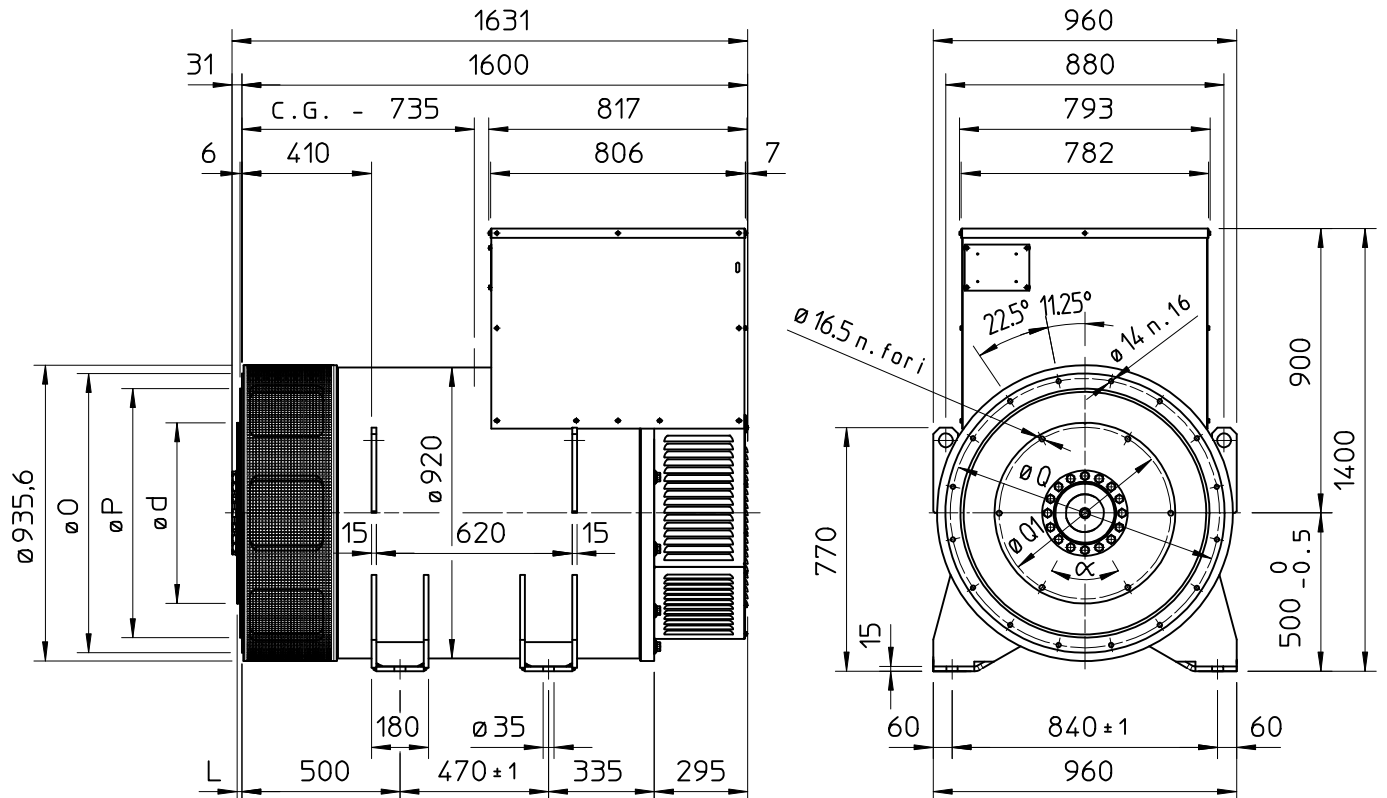

SAE N.	FLANGE		
	O	P	Q
00	883	787,4	850,9
0	711	647,7	679,5

SAE N.	DISC COUPLING				
	d	L	Q1	N.FORI	α
18	571,5	15,7	542,92	6	60°
21	673,1	0	641,35	12	30°

C.G. = GRAVITY CENTER